



TECHNICAL CARD

Thermal input (Kw)	13,8
net weight (Kg)	68
breadth (mm)	800
depth (mm)	700
height (mm)	290

PROFESSIONAL DESCRIPTION

GAS LAVA STONE GRILL, MACROS 700 Line, COMFORT POWER Series, DOUBLE TOP module :

- **worktop and front panels in AISI 304 stainless steel ;**
- regulation of the power supplied via continuously operating tap;
- **pilot flame and thermocouple safety valve ;**
- **piezoelectric ignition** with silicone protection;
- **brazier in AISI 304 stainless steel ;**
- **large cooking surface** with easily removable **cast iron grill ;**
- all components are easily removable for regular maintenance and cleaning operations;
- long length **watertight drawer completely made of steel** for collecting ash and grease;
- lava stone already supplied;
- **cooking area measuring 700 x 515 mm ;**
- **2 year warranty .**

Supplied :







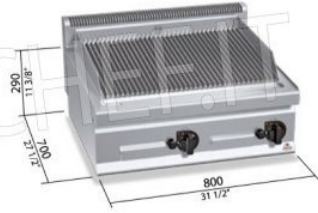

- cast iron grill
- ribbed spatula for gas grill

CE mark
Made in Italy

CODE	DESCRIPTION	PRICE/DELIVERY
------	-------------	----------------



MACROS 700

	cm ²	3.600 (mm 700x515)	
	kW	13,8	
	kcal/h	11.865	
	Btu/h	47.087	
	TOT.		
	G30/G31	kg/h 1,09	
	G20	m ³ /h 1,46	
	G25	m ³ /h 1,70	



MACROS 700

