



**TECNOSERVICE'21 srl**  
 by Tinti Sergio  
 Via Carlo Pisacane, 134  
 61032 Fano (PU) Italy  
 P.IVA IT0200411413

Tel. +39 0721 805911  
 FAX +39 0721 809794  
 e-mail: [staff@technochef.it](mailto:staff@technochef.it)  
[www.technochef.it](http://www.technochef.it)  
[www.technochef.eu](http://www.technochef.eu)

Services and Technologies for professional catering since 1973



CODE	DESCRIPTION	PRICE/DELIVERY
<b>TC-MIXTO</b>	Horizontal countertop refrigerated display case in ABS/white plastic, without protection, temp. operating temperature +2/+10°C, trays excluded, V.230/1, Kw.0.13, Weight 30 Kg, dim.mm.1830x330x230h	<b>Delivery</b> from 4 to 9 days

**PROFESSIONAL DESCRIPTION**

**Horizontal countertop REFRIGERATING DISPLAY CASES , without protection:**

- **structure in high resistance plastic material ( ABS /white plastic),**
- rounded edges both externally and internally,
- anti-reflective surfaces that do not show stains and fingerprints,
- copper evaporator,
- refrigerant gas ECO R134a,
- **Working temperature +2°+10° adjustable with Digital Tele-Thermometer,**
- ECO insulation no CFC,
- low energy consumption,
- dust or flour filter,
- supports for high mounting above the bench,
- **Euro-gastronorm containers not included .**

**Options/Accessories :**

- plexiglass display case.

**CE MARK  
 MADE IN ITALY**



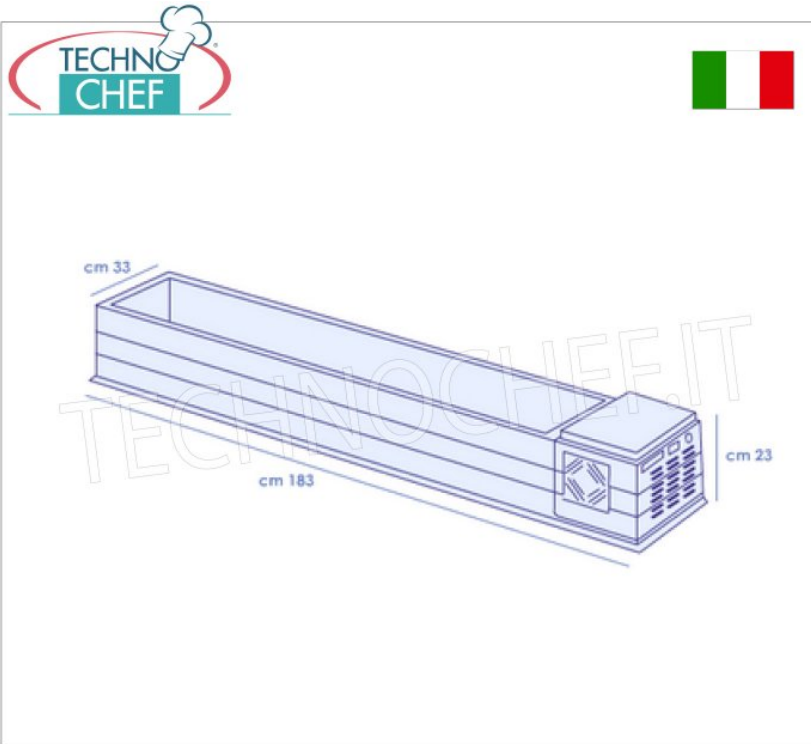

**TECHNICAL CARD**

<b>power supply</b>	Monofase
<b>Volts</b>	V 230/1
<b>frequency (Hz)</b>	50
<b>motor power capacity (Kw)</b>	0,13
<b>net weight (Kg)</b>	22
<b>gross weight (Kg)</b>	30

breadth (mm)	1830
depth (mm)	330
height (mm)	230



Possibili Combinazioni

	1/2 mm 325x265 h 150 lt.9.0		1/4 mm 256x162 h 150 lt.4.1
	1/3 mm 325x175 h 150 lt.5.4		1/6 mm 176x162 h 150 lt.2.3
	1/9 mm 176x108 h 100 lt.1.0		

lt.29 

lt.36 

lt.36 

lt.36 